



SLH SERIES

5-25W, AC-DC CONVERTER

SLH series ----is a compact size power converter offered by Schmid-M. It features universal input voltage, taking both DC and AC input voltage, low power consumption, high efficiency, high reliability, safer isolation. It offers good EMC performance, meets IEC/EN61000-4, CISPR22/EN55022, UL60950 and EN60950 standards, and widely used in industrial, office and civil applications. For harsh EMC environment, this series of products must use the referred application circuit.

PRODUCT FEATURES

1. Universal Input :85 ~ 264VAC,50/60Hz
2. Regulated output, low ripple and noise
3. Efficiency up to 85%
4. Over-current, short circuit and over-temperature protection
5. Plastic case, meets UL94V-0
6. Meets: UL60950 and EN60950
7. Three years warranty
8. Mounting:PCB mounting, Chassis mounting with Screw
Terminals, DIN-Rail mounting

RoHS CE
PART NUMBER SYSTEM

SLH10-10B24A2

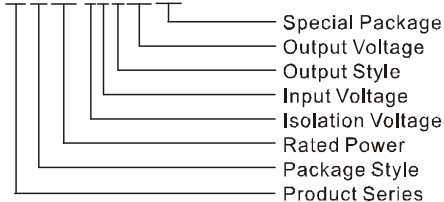

SELECTION GUIDE											
Approval	Model	Package	Power	Output (Vo1/Io1)	Output (Vo2/Io2)	Ripple and Noise(Typ)	Efficiency (%) (Typ.)				
UL/CE	SLH05-10B03	48.5X36X20.5mm	4W	3.3V/1250mA		50mV	70				
UL/CE	SLH05-10B05			5V/1000mA			75				
UL/CE	SLH05-10B09			9V/550mA			77				
UL/CE	SLH05-10B12			12V/420mA			79				
UL/CE	SLH05-10B15			15V/330mA			80				
UL/CE	SLH05-10B24			24V/230mA			82				
	SLH05-10A05		5W		+5V/500mA		-5V/500mA	75			
	SLH05-10A12				+12V/210mA		-12V/210mA	79			
	SLH05-10A15				+15V/160mA		-15V/160mA	79			
	SLH05-10A24				+24V/100mA		-24V/100mA	80			
	SLH05-10C0505-01				5V/800mA		±5V/100mA	70			
	SLH05-10C0512-01				5V/600mA		±12V/100mA	73			
	SLH05-10C0515-01				5V/600mA		±15V/80mA	74			
	SLH05-10C0524-01				5V/600mA		±24V/50mA	75			
	SLH05-10D0505-01				5V/900mA		5V/100mA	71			
	SLH05-10D0512-01				5V/750mA		12V/100mA	73			
	SLH05-10D0515-01				5V/700mA		15V/100mA	73			
	SLH05-10D0524-01				5V/600mA		24V/100mA	75			
UL/CE	SLH10-10B03				55X45X21.0mm		6.6 W	3.3V/2000mA		50mV	70
UL/CE	SLH10-10B05							5V/2000mA			76
UL/CE	SLH10-10B09	9V/1100mA		78							
UL/CE	SLH10-10B12	12V/900mA		80							
UL/CE	SLH10-10B15	15V/700mA		81							
UL/CE	SLH10-10B24	24V/450mA		82							
UL/CE	SLH10-10A05	10W		+5V/1000mA		-5V/1000mA	76				
UL/CE	SLH10-10A12			+12V/450mA		-12V/450mA	80				
UL/CE	SLH10-10A15			+15V/350mA		-15V/350mA	81				
UL/CE	SLH10-10A24			+24V/200mA		-24V/200mA	84				
	SLH10-10C0512-02			5V/1000mA		±12V/200mA	75				
	SLH10-10C0515-02			5V/900mA		±15V/200mA	75				
UL/CE	SLH10-10D0505-02			5V/1800mA		5V/200mA	75				
UL/CE	SLH10-10D0512-02			5V/1500mA		12V/200mA	79				
UL/CE	SLH10-10D0515-02			5V/1400mA		15V/200mA	79				
UL/CE	SLH10-10D0524-02			5V/1000mA		24V/200mA	81				
UL/CE	SLH15-10B03			62X45X22.5mm		9.9W	3.3V/3000mA		50mV		73

Approval	Model	Package	Power	Output (Vo1/Io1)	Output (Vo2/Io2)	Ripple and Noise(Typ)	Efficiency (%) (Typ.)
UL/CE	SLH15-10B05	62X45X22.5mm	15W	5V/2800mA			76
UL/CE	SLH15-10B09			9V/1600mA			78
UL/CE	SLH15-10B12			12V/1250mA			80
UL/CE	SLH15-10B15			15V/1000mA			80
UL/CE	SLH15-10B24			24V/625mA			84
UL/CE	SLH15-10B48			48V/320mA			85
	SLH15-10A05			+5V/1500mA	-5V/1500mA		76
	SLH15-10A12			+12V/650mA	-12V/650mA		81
	SLH15-10A15			+15V/500mA	-15V/500mA		83
	SLH15-10C0505-05			5V/2000mA	±5V/500mA		75
	SLH15-10C0512-02			5V/2000mA	±12V/200mA		77
	SLH15-10C0515-02			5V/1800mA	±15V/200mA		78
	SLH15-10C0524-01			5V/2000mA	±24V/100mA		78
	SLH15-10D0505-08			5V/2200mA	5V/800mA		76
	SLH15-10D0512-04			5V/2000mA	12V/400mA		80
	SLH15-10D0515-03			5V/2000mA	15V/300mA		80
	SLH15-10D0524-02			5V/2000mA	24V/200mA		81
UL/CE	SLH20-10B03			70X48X23.5mm	20W		3.3V/4100mA
UL/CE	SLH20-10B05	5V/3500mA				75	
UL/CE	SLH20-10B09	9V/2100mA				77	
UL/CE	SLH20-10B12	12V/1600mA				81	
UL/CE	SLH20-10B15	15V/1300mA				83	
UL/CE	SLH20-10B24	24V/850mA				85	
	SLH20-10A05	+5V/2000mA	-5V/2000mA			75	
	SLH20-10A12	+12V/830mA	-12V/830mA			82	
	SLH20-10A15	+15V/650mA	-15V/650mA			83	
	SLH20-10C0512-04	5V/2000mA	±12V/400mA			75	
	SLH20-10C0515-03	5V/2000mA	±15V/300mA			76	
	SLH20-10C0524-02	5V/2000mA	±24V/200mA			77	
	SLH20-10D0512-06	5V/2500mA	12V/600mA			75	
	SLH20-10D0524-03	5V/2500mA	24V/300mA			77	
UL/CE	SLH25-10B03	70X48X23.5mm	25W	3.3V/4100mA		50mV	73
UL/CE	SLH25-10B05			5V/4100mA			74
UL/CE	SLH25-10B09			9V/2500mA			78
UL/CE	SLH25-10B12			12V/2100mA			82
UL/CE	SLH25-10B15			15V/1600mA			83
UL/CE	SLH25-10B24			24V/1100mA			85
UL/CE	SLH25-10B48			48V/500mA			87

Note: SLH05-10AXX sample Vo2 for feedback; SLH10/15/20-10AXX sample positive and negative output for feedback; others sample Vo1 for feedback.

INPUT SPECIFICATIONS

Input voltage range	85~264VAC, 120~370VDC		
Input frequency	47~63Hz		
Input current	SLH05 models SLH10 models SLH15 models SLH20 models SLH25 models	110VAC 120mA, typ 230mA, typ 250mA, typ 330mA, typ 420mA, typ	230VAC 70mA, typ 120mA, typ 140mA, typ 180mA, typ 230mA, typ
Inrush current	SLH05 models SLH10 models SLH15 models SLH20/SLH25 models	110VAC 10A, typ 10A, typ 10A, typ 16A, typ	230VAC 20A, typ 20A, typ 20A, typ 30A, typ
Leakage current	0.3mA RMS typ./230VAC/50Hz		
Recommended External Input Fuse (Special package series include fuse)	SLH05 models SLH10/SLH15 models SLH20/SLH25 models	1A/250V 2A/250V 3.15A/250V	Slow-Blow Slow-Blow Slow-Blow

OUTPUT SPECIFICATIONS

Voltage set accuracy		±2%	
Input variation		±0.5%	(main output)
		±1.5%	(supplement output)
Load variation (10-100%)	Single output models	±1%	
	Dual output models (balanced load)	±2%	
	Isolated triple output (balanced load)	Vo1: ±3%	(main output)
		±Vo2: ±5%	(supplement output)
	Isolated and separated twin output (balanced load)	Vo1: ±3%	(main output)
		Vo2: ±5%	(supplement output)
Minimum load	single output models	0%	
	Dual output models (balanced load)	10%	
	Isolated and separated twin output (balanced load)	10%	
	Isolated triple output (balanced load)	10%	
Ripple & noise(p-p)	(20MHz Bandwidth)	50mV (Typ)	100mV (Max)
Short circuit protection		Continuous, and auto resume	
Over current protection		≥ 110% Io	
Output over-voltage protection	3.3 / 5VDC models	≤7.5VDC	
	9VDC models	≤12VDC	
	12 / 15VDC models	≤20VDC	
	24VDC models	≤30VDC	
	48VDC models	≤60VDC	

COMMON SPECIFICATIONS

Temperature ranges	Operating temperature :	-40℃~+70℃		
	Power derating (55℃~70℃)	3.75% / ℃		
	(-40℃~-10℃)	2% / ℃		
	Storage temperature:	-40℃~+105℃		
	Case temperature:	+90℃ max		
Hold-up time	(Vin=230VAC)	80ms(typ)		
Humidity (non condensing)		95%(max)		
Temperature coefficient		0.02%/℃ (main output)		
		0.15%/℃ (supplement output)		
Switching frequency		65kHz(typ.)		
I/O-isolation voltage		3000VAC/1Min		
EMC	EMI	CE	CISPR22/EN55022, CLASS B(without external circuit)	
		RE	CISPR22/EN55022, CLASS B(without external circuit)	
	EMS	ESD	IEC/EN 61000-4-2 Contact ±6KV / Air ±8KV	perf. Criteria B
		RS	IEC/EN 61000-4-3 10V/m	perf. Criteria A
		EFT	IEC/EN 61000-4-4 ±2KV(without external circuit)	perf. Criteria B
			IEC/EN 61000-4-4 ±4KV (with typical applications Figure 6)	perf. Criteria B
		Surge	IEC/EN 61000-4-5 ±1KV/±2KV(without external circuit)	perf. Criteria B
			IEC/EN 61000-4-5 ±2KV/±4KV (with typical applications Figure 6)	perf. Criteria B
Safety standards		IEC60950,EN60950,UL60950		
Safety approvals		EN60950,UL60950		
Safety Class	SLH15-10BXX	CLASS II		
	Others	CLASS I		
Case material		UL94V-0		
Install		PCB mounting, Chassis mounting with Screw Terminals, DIN-Rail mounting		
MTBF		>300,000H @25℃		

Note:

1. Ripple and Noise are measured by the method of parallel lines;

2. All specifications measured at Ta=25°C, humidity<75%, nominal input voltage and rated output load unless otherwise specified;

3. All characteristics are for listed model only, non-standard models may perform differently, please contact our technical person for more detail.

PARALLEL LINES MEASURE

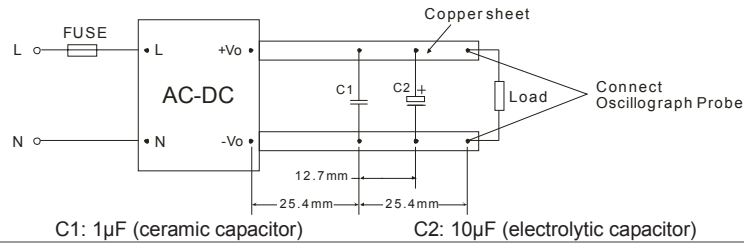

C1: 1μF (ceramic capacitor)

C2: 10μF (electrolytic capacitor)

TYPICAL EFFICIENCY CURVE

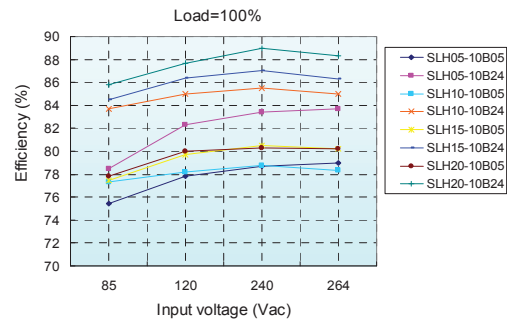
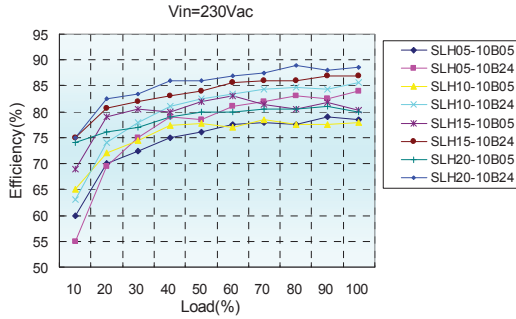

INPUT VOLTAGE VS LOAD

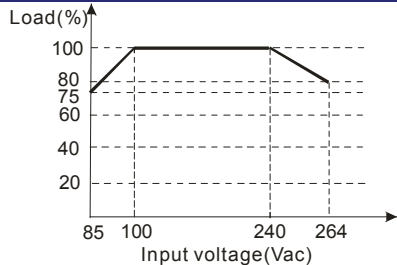

*Note: When input DC, $V_{dc}=1.414*V_{ac}-20$.

TEMPERATURE VS LOAD

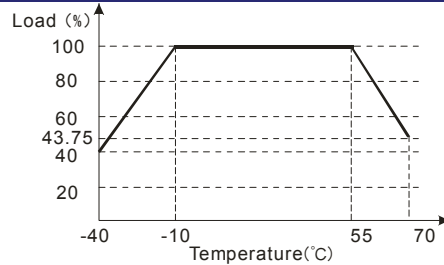

TRIM APPLICATION & TRIM CALCULATION

Application circuit for TRIM
(Part in broken line is the interior of models)

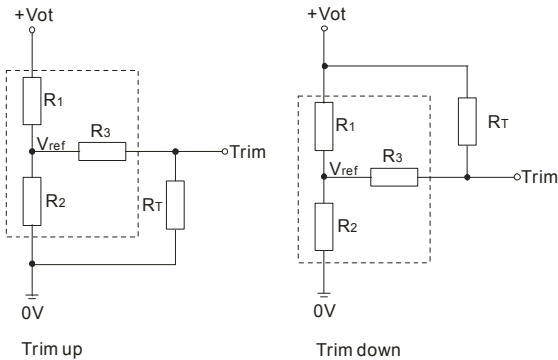

Formula for resistance of Trim

$$\text{up: } R_T = \frac{aR_2}{R_2 - a} - R_3 \quad a = \frac{V_{ref}}{V_{ot} - V_{ref}} \cdot R_1$$

$$\text{down: } R_T = \frac{aR_1}{R_1 - a} - R_3 \quad a = \frac{V_{ot} - V_{ref}}{V_{ref}} \cdot R_2$$

Note: Value for R1, R2, R3, and Vref refer to the following table.

R_T: Resistance of Trim

a: User-defined parameter, no actual meanings.

Resistance \ Vo(V)	3.3	5	9	12	15	24	48
R1(KΩ)	2	3.3	7.5	3.8	7.5	8.6	1.2
R2(KΩ)	1.2	3.3	2.8	1	1.5	1	22
R3(KΩ)	1	1	1	1	1	1	1.2
Vref(V)	1.2	2.5	2.5	2.5	2.5	2.5	2.5
Vot(V)	Output voltage of Trim, variation ≤ ±10%						

TYPICAL APPLICATIONS

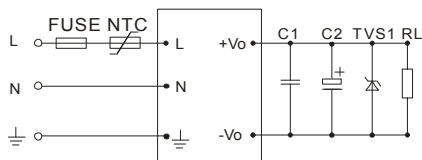

Figure 1: SLH**-10B** (Single Output)

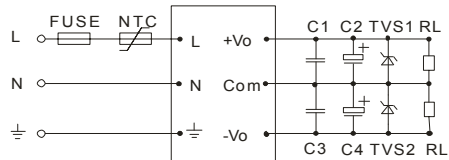

Figure 2: SLH**-10A** (Dual Output)

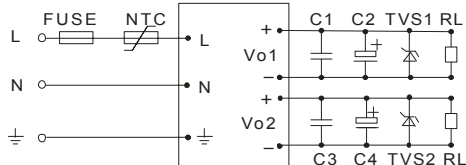

Figure 3: SLH**-10D** (Isolate Twin Output)

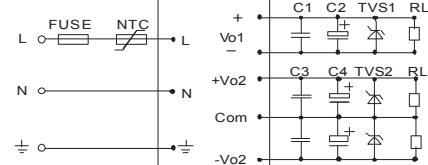

Figure 4: SLH**-10C** (Triple Output)

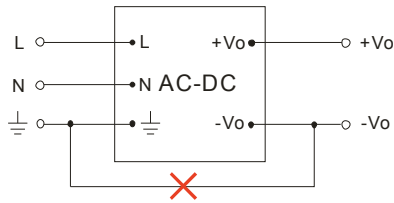

Figure 5: Note: This application is not supported for this series.

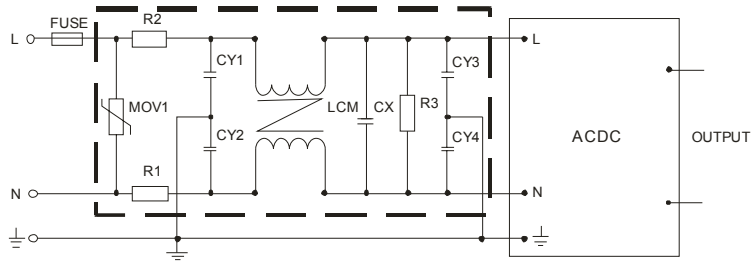

Figure 6: SLH05-25 series Recommended circuit for application require higher EMC standard (external circuit output same as above)

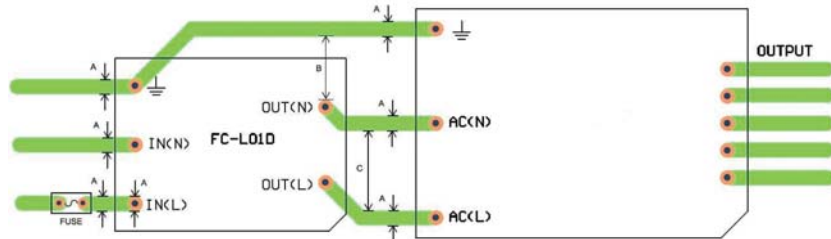

Figure 7: EMC application circuit PCB layout
Safety and recommend wiring: linewidth $A \geq 3\text{mm}$, $B \geq 6\text{mm}$, $C \geq 9\text{mm}$

EXTERNAL CAPACITORS TYPICAL VALUE(Unit: μF)

MODEL	C2	C4	C6	TVS1	TVS2	TVS3
SLH05-10B03	330			SMBJ7.0A		
SLH05-10B05	330			SMBJ7.0A		
SLH05-10B09	120			SMBJ12A		
SLH05-10B12	120			SMBJ20A		
SLH05-10B15	68			SMBJ20A		
SLH05-10B24	68			SMBJ30A		
SLH05-10A05	120	120		SMBJ7.0A	SMBJ7.0A	
SLH05-10A12	68	68		SMBJ20A	SMBJ20A	
SLH05-10A15	47	47		SMBJ20A	SMBJ20A	
SLH05-10A24	10	10		SMBJ30A	SMBJ30A	
SLH05-10C0505-01	220	22	22	SMBJ7.0A	SMBJ7.0A	SMBJ7.0A
SLH05-10C0512-01	120	22	22	SMBJ7.0A	SMBJ20A	SMBJ20A
SLH05-10C0515-01	120	22	22	SMBJ7.0A	SMBJ20A	SMBJ20A
SLH05-10C0524-01	120	22	22	SMBJ7.0A	SMBJ30A	SMBJ30A
SLH05-10D0505-01	220	22		SMBJ7.0A	SMBJ7.0A	
SLH05-10D0512-01	220	22		SMBJ7.0A	SMBJ20A	
SLH05-10D0515-01	120	22		SMBJ7.0A	SMBJ20A	
SLH05-10D0524-01	120	22		SMBJ7.0A	SMBJ30A	
SLH10-10B03	470			SMBJ7.0A		
SLH10-10B05	330			SMBJ7.0A		
SLH10-10B09	120			SMBJ12A		
SLH10-10B12	120			SMBJ20A		
SLH10-10B15	120			SMBJ20A		
SLH10-10B24	68			SMBJ30A		
SLH10-10A05	220	220		SMBJ7.0A	SMBJ7.0A	
SLH10-10A12	120	120		SMBJ20A	SMBJ20A	
SLH10-10A15	47	47		SMBJ20A	SMBJ20A	
SLH10-10A24	33	33		SMBJ30A	SMBJ30A	
SLH10-10C0512-02	220	68	68	SMBJ7.0A	SMBJ20A	SMBJ20A
SLH10-10C0515-02	220	47	47	SMBJ7.0A	SMBJ20A	SMBJ20A
SLH10-10D0505-02	220	68		SMBJ7.0A	SMBJ7.0A	
SLH10-10D0512-02	220	68		SMBJ7.0A	SMBJ20A	
SLH10-10D0515-02	220	47		SMBJ7.0A	SMBJ20A	
SLH10-10D0524-02	220	47		SMBJ7.0A	SMBJ30A	
SLH15-10B03	680			SMBJ7.0A		
SLH15-10B05	680			SMBJ7.0A		
SLH15-10B09	470			SMBJ12A		
SLH15-10B12	220			SMBJ20A		
SLH15-10B15	220			SMBJ20A		
SLH15-10B24	68			SMBJ30A		
SLH15-10B48	33			SMBJ64A		

SLH15-10A05	470	470		SMBJ7.0A	SMBJ7.0A	
SLH15-10A12	220	220		SMBJ20A	SMBJ20A	
SLH15-10A15	120	120		SMBJ20A	SMBJ20A	
SLH15-10C0505-05	470	220	220	SMBJ7.0A	SMBJ7.0A	SMBJ7.0A
SLH15-10C0512-02	470	120	120	SMBJ7.0A	SMBJ20A	SMBJ20A
SLH15-10C0515-02	470	120	120	SMBJ7.0A	SMBJ20A	SMBJ20A
SLH15-10C0524-01	470	120	120	SMBJ7.0A	SMBJ30A	SMBJ30A
SLH15-10D0505-08	470	470		SMBJ7.0A	SMBJ7.0A	
SLH15-10D0512-04	470	220		SMBJ7.0A	SMBJ20A	
SLH15-10D0515-03	470	120		SMBJ7.0A	SMBJ20A	
SLH15-10D0524-02	470	47		SMBJ7.0A	SMBJ30A	
SLH20-10B03	330			SMBJ7.0A		
SLH20-10B05	330			SMBJ7.0A		
SLH20-10B09	220			SMBJ12A		
SLH20-10B12	220			SMBJ20A		
SLH20-10B15	220			SMBJ20A		
SLH20-10B24	220			SMBJ30A		
SLH20-10A05	470	470		SMBJ7.0A	SMBJ7.0A	
SLH20-10A12	120	120		SMBJ20A	SMBJ20A	
SLH20-10A15	68	68		SMBJ20A	SMBJ20A	
SLH20-10C0512-04	330	120	120	SMBJ7.0A	SMBJ20A	SMBJ20A
SLH20-10C0515-03	330	120	120	SMBJ7.0A	SMBJ20A	SMBJ20A
SLH20-10C0524-02	330	47	47	SMBJ7.0A	SMBJ30A	SMBJ30A
SLH20-10D0512-06	330	220		SMBJ7.0A	SMBJ20A	
SLH20-10D0524-03	330	120		SMBJ7.0A	SMBJ30A	
SLH25-10B03	330			SMBJ7.0A		
SLH25-10B05	330			SMBJ7.0A		
SLH25-10B09	330			SMBJ12A		
SLH25-10B12	330			SMBJ20A		
SLH25-10B15	330			SMBJ20A		
SLH25-10B24	120			SMBJ30A		
SLH25-10B48	68			SMBJ64A		

Note:

- Output filtering capacitors C2, C4 and C6 are electrolytic capacitors. It is recommended to use high frequency and low impedance electrolytic capacitors. For capacitance and current of capacitor please refer to manufacture's datasheet. Voltage derating of capacitor should be 80% or above. C1,C3,C5 are use to filter high frequency noise, suggest choose 1μF. TVS is recommended component to protect post-circuits (if converter fails). External input NTC is recommended to use 5D-9.
- For standard EMC requirement, please refer to figure 1, figure 2, figure 3 or figure 4, if higher EMC requirement ,please refer to figure 6.
 MOV: Varistor, model: 561KD14, it is used to protect the device under surge;
 R1、R2: 2Ω/3W Winding resistor;
 R3: 1MΩ/2W;
 CY1、CY2、CY3、CY4: 102M/400VAC;
 CX: 224K/275VAC;
 LCM: 10mH-30mH; .
- FUSE: SLH05 recommended to use 1A/250V, SLH10/SLH15 recommended to use 2A/250V, SLH20/SLH25 recommended to use 3.15A/250V.

PCB MOUNTING WITH SOLDER PINS

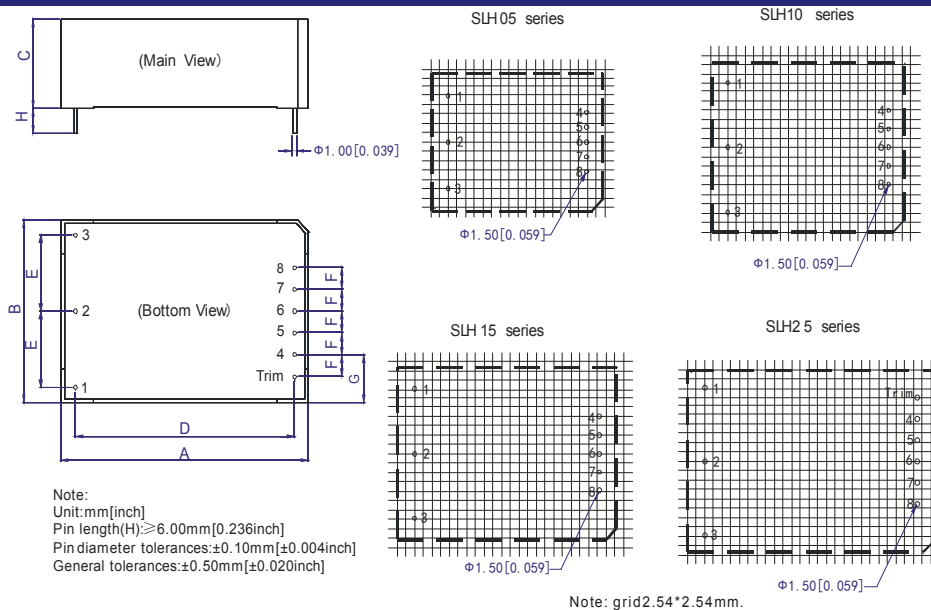

OUTLINE AND DIMENSIONS (Unit: mm)					
NO.	SLH05	SLH10	SLH15	SLH20	SLH25
A	48.50	55.00	62.00	70.00	70.00
B	36.00	45.00	45.00	48.00	48.00
C	20.50	21.00	22.50	23.50	23.50
D	40.50	47.00	54.00	62.00	62.00
E	12.50	17.50	17.50	20.00	20.00
F	4.00	5.00	5.00	5.75	5.75
G	10.00	12.50	12.50	12.50	12.50

MODELS WEIGHT					
WEIGHT T	SLH05	SLH10	SLH15	SLH20	SLH25
(Typ.)	50g	70g	80g	120g	120g

FOOTPRINT DETAILS				
Pin	SLHX-10B	SLHXX-10A	SLHXX-10C	SLHXX-10D
1				
2	AC(N)	AC(N)	AC(N)	AC(N)
3	AC(L)	AC(L)	AC(L)	AC(L)
4	-Vo	-Vo	-Vo1	-Vo1
5	No Pin	No Pin	+Vo1	+Vo1
6	No Pin	COM	-Vo2	No Pin
7	No Pin	No Pin	COM	-Vo2
8	+Vo	+Vo	+Vo2	+Vo2
Trim	Trim**	No Pin	No Pin	No Pin

There is no pin "1" on SLH15-10BXX
Trim**: only for SLH20/25-10BXX Series.

SLHXXA2 CHASSIS MOUNTING WITH SCREW TERMINALS

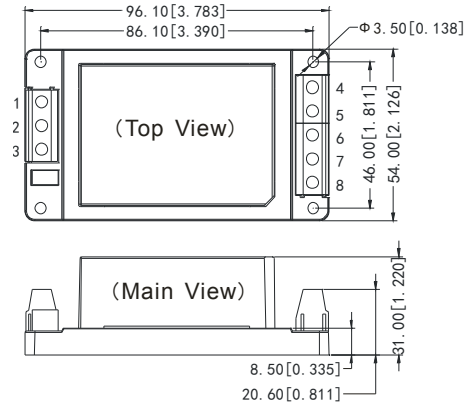

Note:
Unit: mm[inch]
General tolerances: $\pm 0.50\text{mm}[\pm 0.020\text{inch}]$

*The figure above is related to SLH15 series, the height of other series is different.

OUTLINE AND DIMENSIONS (Unit: mm)	
MODEL	DIMENSIONS
SLH05XXA2	96.1x54x29
SLH10XXA2	96.1x54x29.5
SLH15XXA2	96.1x54x31
SLH20XXA2	96.1x54x32
SLH25XXA2	96.1x54x32

MODELS WEIGHT					
WEIGHT	SLH05	SLH10	SLH15	SLH20	SLH25
Typ.	100g	120g	130g	170g	170g

FOOTPRINT DETAILS				
Pin	SLHXX-10B	SLHXX-10A	SLHXX-10C	SLHXX-10D
1				
2	AC(N)	AC(N)	AC(N)	AC(N)
3	AC(L)	AC(L)	AC(L)	AC(L)
4	-Vo	-Vo	-Vo1	-Vo1
5	NC	NC	+Vo1	+Vo1
6	NC/Trim**	COM	-Vo2	NC
7	NC	NC	COM	-Vo2
8	+Vo	+Vo	+Vo2	+Vo2

There is no pin "1" on SLH15-10BXXA2.
NC/Trim** : The pin is Trim on SLH20/25-10BXXA2 ,
The pin is not connected on other single output products.

SLHXXA4 DIN-RAIL MOUNTING

OUTLINE AND DIMENSIONS (Unit: mm)	
MODEL	DIMENSIONS
SLH05XXA4	96.1x54x33.6
SLH10XXA4	96.1x54x34.1
SLH15XXA4	96.1x54x35.6
SLH20XXA4	96.1x54x36.6
SLH25XXA4	96.1x54x36.6

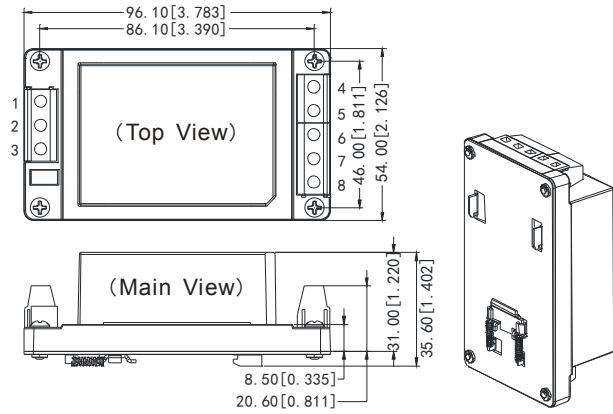

Note:
Unit: mm[inch]
General tolerances: $\pm 0.50\text{mm}[\pm 0.020\text{inch}]$

MODELS WEIGHT					
WEIGHT	SLH05	SLH10	SLH15	SLH20	SLH25
Typ.	140g	160g	170g	210g	210g

* The figure above is related to SLH15 series, the height of other series is different.
**Footprint Details are the same as Chassis mounting with Screw Terminals'.

PACKAGE DIAGRAM

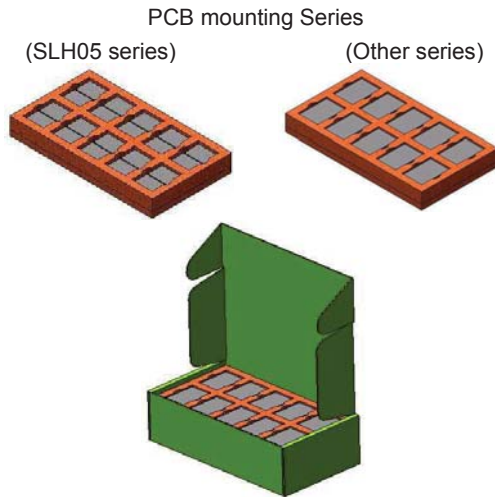

Inner packaging box dimensions: L*W*H=355*192*93mm
Packaging quantity: 20pcs (SLH05 series: 40pcs)
Outer packaging box dimensions: L*W*H=405*380*305mm
Packaging quantity: 120pcs (SLH05 series: 240pcs)

Special Package Series

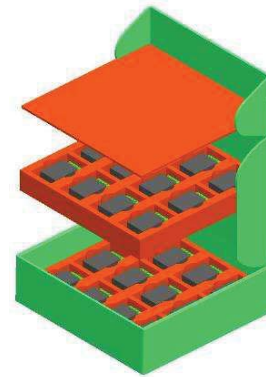

Inner packaging box dimensions: L*W*H=365*350*105mm
Packaging quantity: 24pcs
Outer packaging box dimensions: L*W*H=390*360*245mm
Packaging quantity: 48pcs