

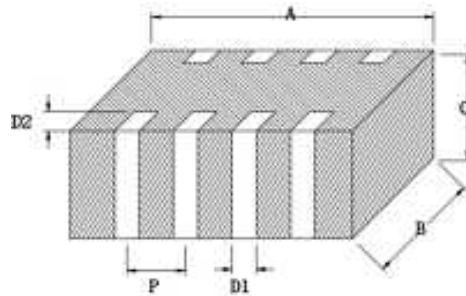

SMD Chip Bead Array – SCA Series

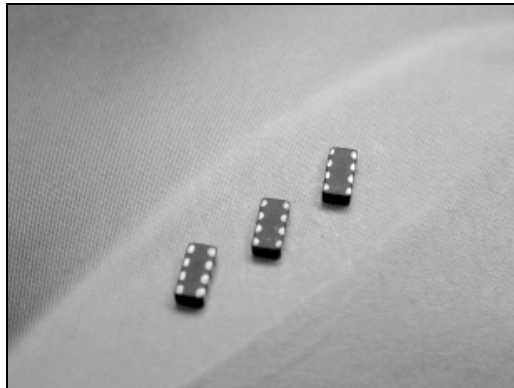

Features

- SCA series consists of 4 circuits
- SCA series is suitable for EMI suppression in small digital equipment
- Excellent solderability and resistance to soldering heat
- Closed magnetic circuit avoids crosstalk

Dimensions

| | | | | | |
|----------|-----------|-----------|-----------|-----------|-----------|
| Part No. | A | B | C | D | D1 |
| SCA3216 | 3.2 ± 0.2 | 1.6 ± 0.2 | 0.8 ± 0.2 | 0.4 ± 0.2 | 0.4 ± 0.2 |
| | D2 | P | | | |
| | 0.3 ± 0.2 | 0.8 ± 0.1 | | | |
| QTY/REEL | 3000pcs. | | | | |

Ordering Information

SCA 3216 K 4-121

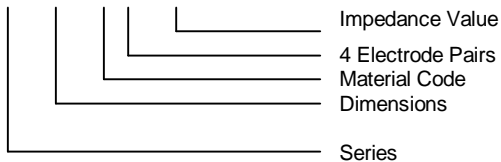

Characteristics

| Part No. | Impedance (Ω) | Test Frequency (MHz) | DC Resistance (Ω)Max. | Rated Current (mA)Max. |
|---------------|---------------|----------------------|-----------------------|------------------------|
| SCA3216K4-300 | 30 ± 25% | 100 | 0.10 | 200 |
| SCA3216K4-600 | 60 ± 25% | 100 | 0.25 | 200 |
| SCA3216K4-121 | 120 ± 25% | 100 | 0.30 | 150 |
| SCA3216K4-221 | 220 ± 25% | 100 | 0.30 | 150 |
| SCA3216K4-301 | 300 ± 25% | 100 | 0.40 | 150 |
| SCA3216K4-601 | 600 ± 25% | 100 | 0.50 | 100 |
| SCA3216K4-102 | 1000 ± 25% | 100 | 0.70 | 50 |
| SCA3216M4-121 | 120 ± 25% | 100 | 0.40 | 150 |
| SCA3216M4-221 | 220 ± 25% | 100 | 0.45 | 150 |
| SCA3216M4-301 | 300 ± 25% | 100 | 0.50 | 150 |
| SCA3216M4-471 | 470 ± 25% | 100 | 0.55 | 100 |
| SCA3216M4-601 | 600 ± 25% | 100 | 0.65 | 100 |



SCA3216K4-121

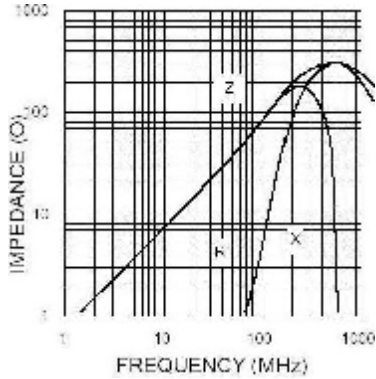

SCA3216K4-102

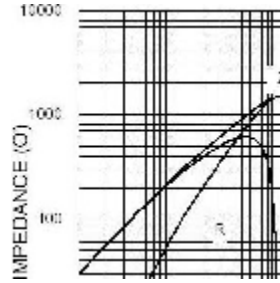

SCA3216M4-121

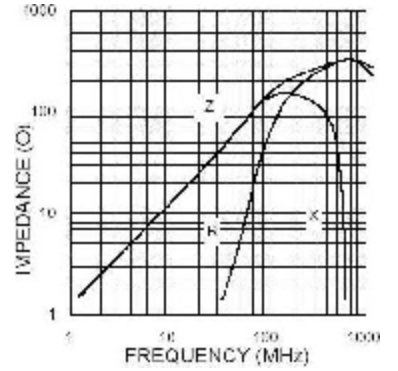

SCA3216K4-301

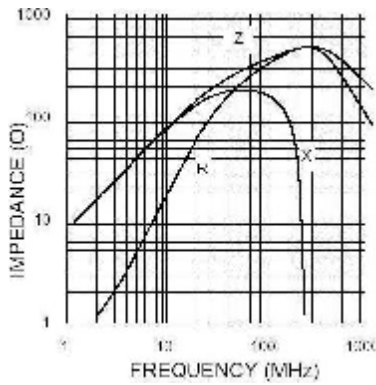

SCA3216K4-600

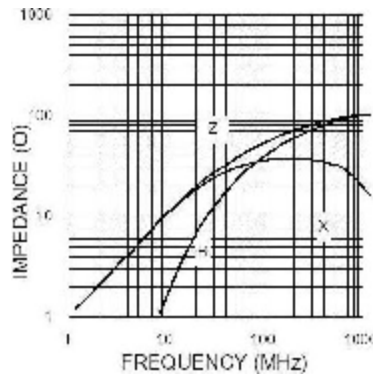

SCA3216K4-601

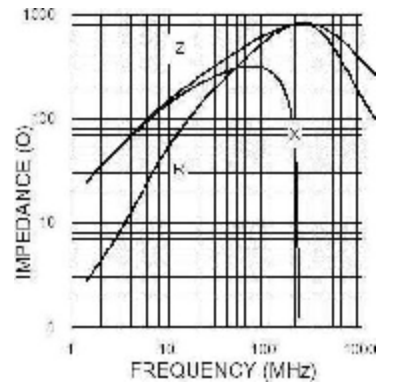

SCA3216M4-221

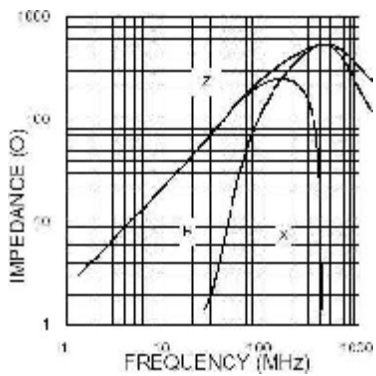

SCA3216M4-301

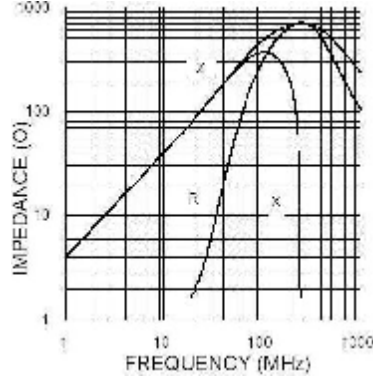

SCA3216M4-47

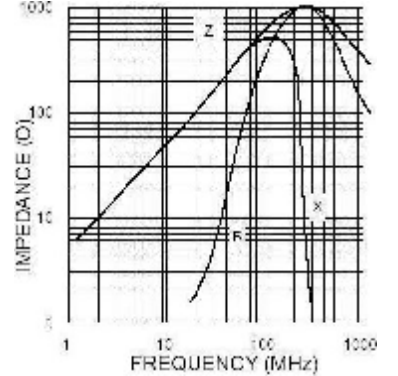

SCA3216K4-300

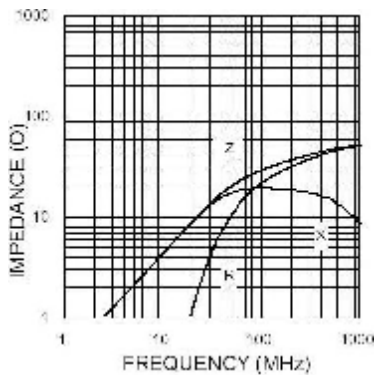

SCA3216K4-221

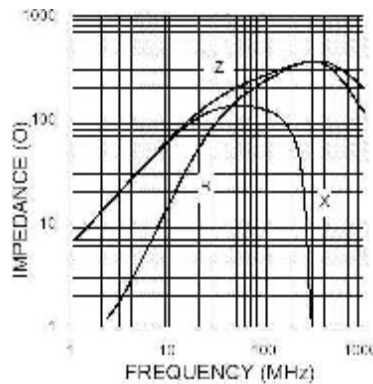

SCA3216M4-601

